

Model No.: GP100AAHC

Type	: Rechargeable Nickel Metal Hydride Cylindrical Cell
Nominal Dimension (with Sleeve)	: $\Phi = 10.5\text{mm}$ H = 44.5mm
Applications	: Recommended discharge current 93 to 2790 mA
Nominal Voltage	: 1.2V
Capacity	: Nominal: 930mAh Minimum: 930mAh Typical: 970mAh When discharged at 186mA to 1.0V at 20°C
Charging Condition	: 93mA for 16 hrs at 20°C
Fast Charge	: 465mA to 930mA (0.5 to 1C) charge termination control recommended control parameters: - ΔV : 0-5mV **DT/dt : 0.8°C/min (0.5 to 0.9C) 0.8 - 1°C/min (1C) **TCO : 45 - 50°C **Timer : 105% nominal input **for ref. only
Service Life	: >500 cycles (IEC standard)
Continuous Overcharge	: 93mA maximum current for 1 year. No conspicuous deformation and/or leakage
Weight	: 15.2g
Internal Resistance	: Average 40m Ω upon fully charged (Range 24 - 55m Ω) at 1000Hz
Max. Charging Voltage	: 1.5V at 93mA charging
Ambient Temperature Range	: Standard Charge : 0 to 45°C Fast Charging : 10 to 45°C Discharge : -20 to 50°C Storage : -20 to 35°C

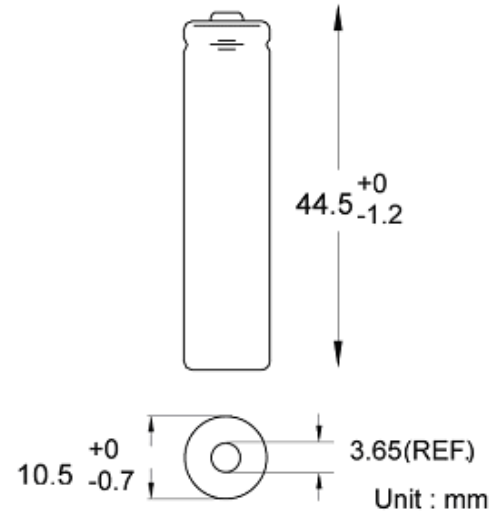

Low Rate Discharge

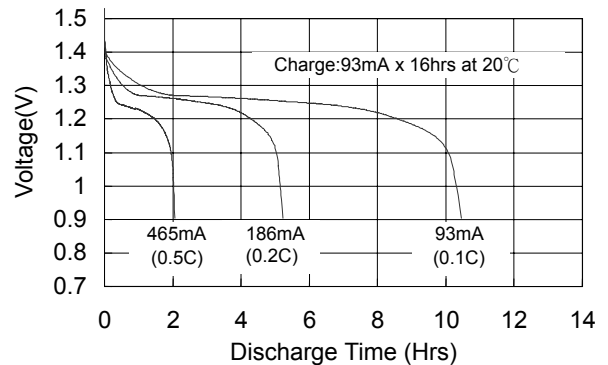

Fast Charge (Charge Control Required)

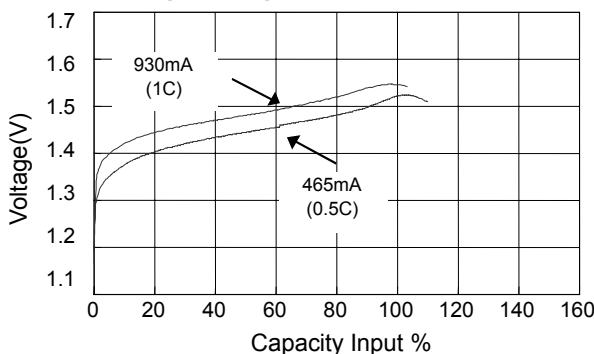

High Rate Discharge

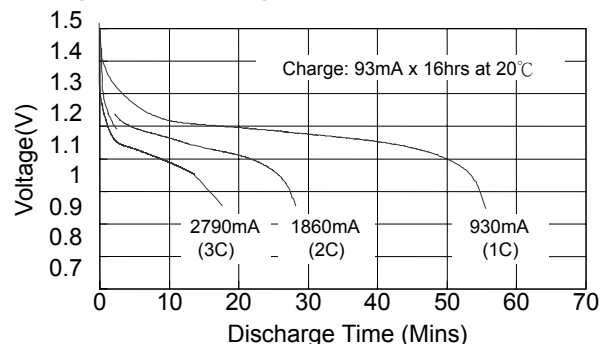

The information (subject to change without prior notice) contained in this document is for reference only and should not be used as a basis for product guarantee or warranty. For applications other than those described here, please consult your nearest GP Sales and Marketing Office or Distributors.