

Panel min. 0,8 max. 6,5 mm.

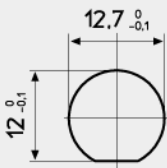
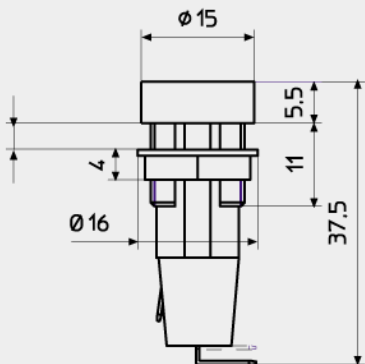

Mounting hole