

K3690A

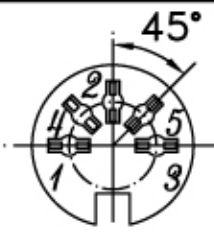

K3690B



K3690C

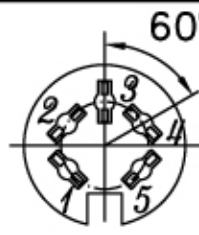

K3690D

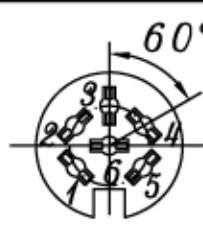

K3690F

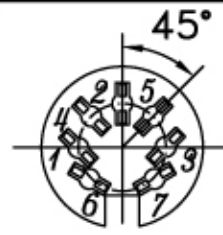

K3690G

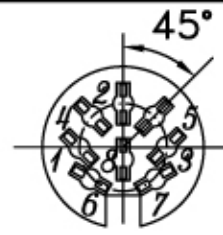

K3690H

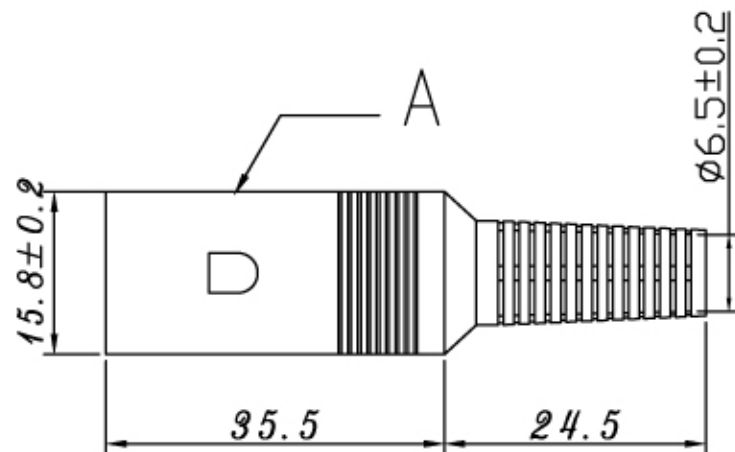
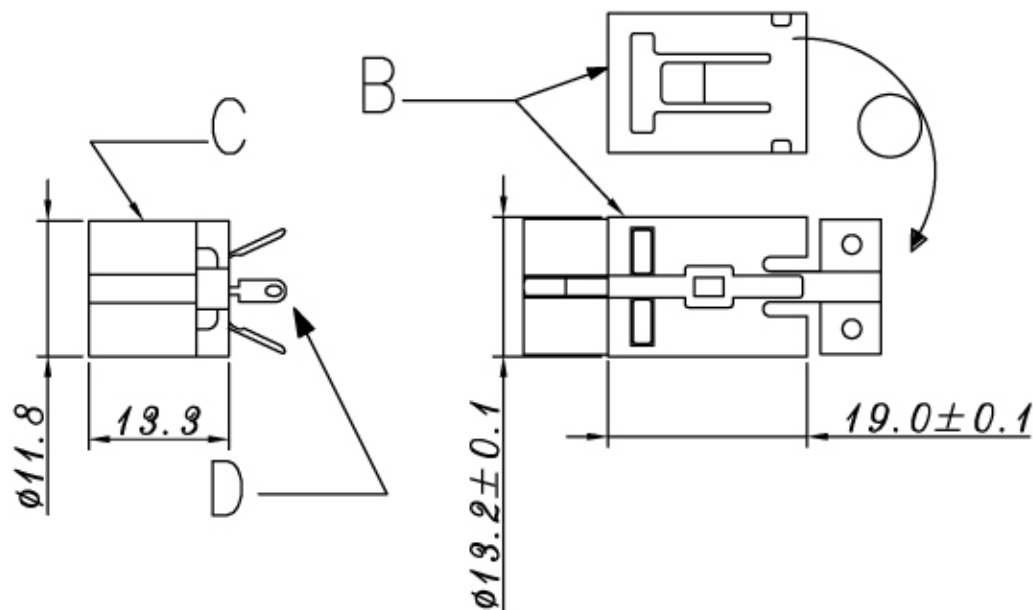

MATERIALS

A.BOOT: EVA

B.METAL PART:STEEL NICKEL PLATED

C.INSULATOR:PC

D.PIN CONTACT:BRASS SILVER PLATED

TOLERANCES		PART NUMBER	
.X ± 0.1 .XXX ± /		K3690x series	
.XX ± 0.05 ANGLES /		DESCRIPTION	
DRAFT		DIN JACK	
MAGGIE HSU051910		ASS'Y TYPE	
CHECK		REV.	
JANNE HUNG		A	
APPROVAL		SHEET	
DANNY HSU		1/1	