



EVERLIGHT ELECTRONICS CO.,LTD.

Device Number : CDLE-125-001 REV.: 2

3.0mm Round Type LED Lamps

PART NO. : 1254HD

ECN: _____

Page: 1/4

■ Features :

- Choice of various viewing angles
- Available on tape and reel.
- Reliable and robust

■ Descriptions :

- The series is specially designed for applications requiring higher brightness
- The led lamps are available with different colors, intensities,

■ Applications :

- TV set
- Monitor
- Telephone
- Computer

■ Package Dimensions:

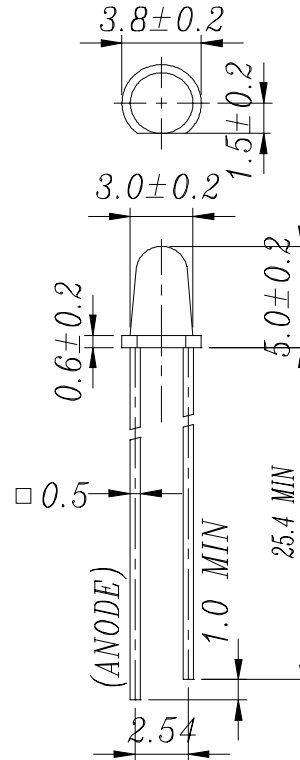

■ Notes :

1. All dimensions are in millimeters.
2. An epoxy meniscus may extend about 1.5mm(0.059") down to the lead.
3. Tolerances unless Dimension ± 0.25 mm.

PART NO.	Chip		Lens Color
	Material	Emitted Color	
1254HD	GaP	Bright Red	Red Diffused

Office : 7C Building, Lian Hua Port Industrial District, Lian Hua Shan
 Bonded Processing Zone Pan Yu, Guang Zhou, China
 TEL : (020)84860913,84860914
 FAX : (020)84860600
 http : //www.everlight.com



EVERLIGHT ELECTRONICS CO.,LTD.

Device Number : CDLE-125-001 REV.: 2

5.0mm Round Type LED Lamps

PART NO. : 1254HD ECN : _____ Page: 2/4

■ Absolute Maximum Ratings at Ta = 25°C

Parameter	Symbol	Rating	Unit
Forward Current	I _F	15	mA
Operating Temperature	T _{opr}	-40 to +85	°C
Storage Temperature	T _{stg}	-40 to +100	°C
Soldering Temperature	T _{sol}	260 ± 5	°C
Power Dissipation	P _d	45	mW
Peak Forward Current(Duty 1/10 @ 1KHz)	I _{F(Peak)}	50	mA
Reverse Voltage	V _R	5	V

■ Electronic Optical Characteristics :

Parameter	Symbol	Min.	Typ.	Max.	Unit	Condition
Luminous Intensity	I _v	0.63	1.60	/	mcd	I _F = 10 mA
Viewing Angle	2θ 1/2	/	40	/	deg	I _F = 10 mA
Peak Wavelength	λ _p	/	697	/	nm	I _F = 10 mA
Dominant Wavelength	λ _d	/	650	/	nm	I _F = 10 mA
Spectrum Radiation Bandwidth	Δλ	/	90	/	nm	I _F = 10 mA
Forward Voltage	V _F	1.5	2.0	2.4	V	I _F = 10 mA
Reverse Current	I _R	/	/	10	μA	V _R = 5 V



EVERLIGHT ELECTRONICS CO.,LTD.

Device Number : CDLE-125-001 REV.: 2

3.0mm Round Type LED Lamps

PART NO. : 1254HD

ECN : _____ Page: 3/4

Typical Electro-Optical Characteristic Curves:

(H)

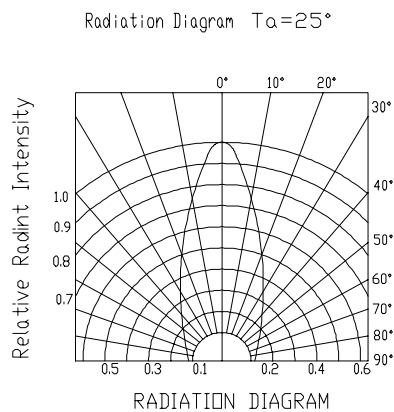
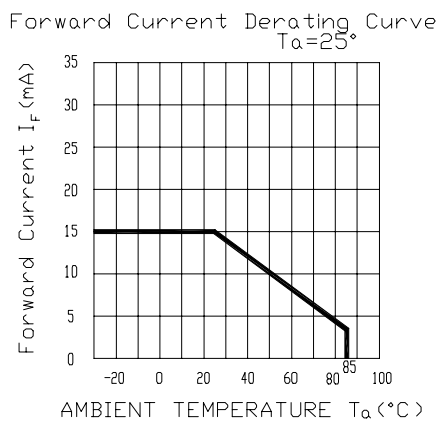
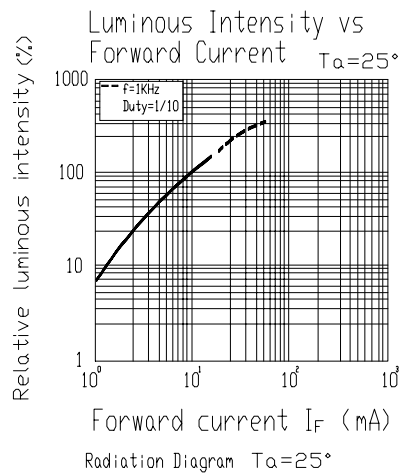
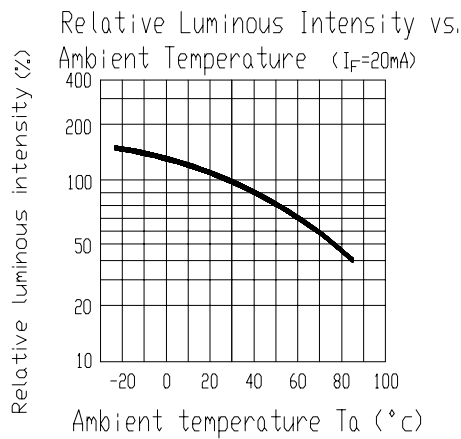
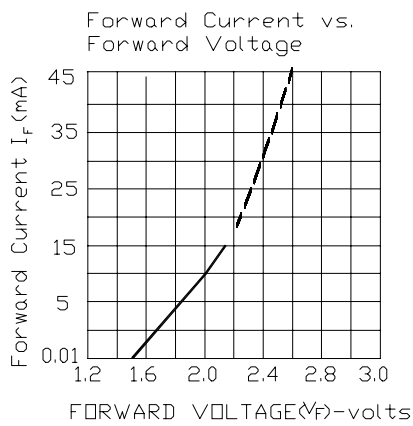
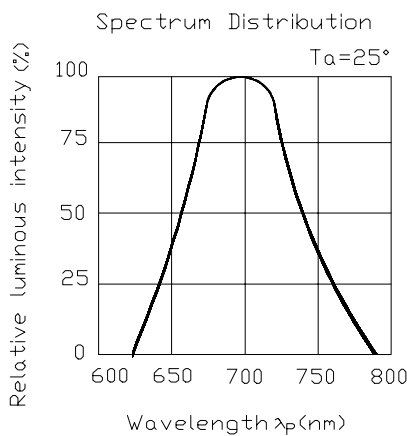



EVERLIGHT ELECTRONICS CO.,LTD.

Device Number : CDLE-125-001 REV.: 2

3.0mm Round Type LED Lamps

PART NO. : 1254HD ECN : Page: 4/4

■ Reliability test items and conditions:

NO	Item	Test Conditions	Test Hours/Cycle		Ac/Re
1	Solder Heat	TEMP : 260°C ± 5 °C	5 SEC	76 PCS	0/1
2	Temperature Cycle	H : +85°C 30min ∩ 5 min L : -55°C 30min	50 CYCLES	76 PCS	0/1
3	Thermal Shock	H : +100°C 5min ∩ 10 sec L : -10°C 5min	50 CYCLES	76 PCS	0/1
4	High Temperature Storage	TEMP : 100°C	1000 HRS	76 PCS	0/1
5	Low Temperature Storage	TEMP : -55°C	1000 HRS	76 PCS	0/1
6	DC Operating Life	TEMP : 25°C IF = 10mA	1000 HRS	76 PCS	0/1
7	High Temperature / High Humidity	85°C / 85% RH	1000 HRS	76 PCS	0/1