

Selection Guide

Part No.	Dice	Lens Type	Iv (ucd) @ 10mA		Description
			Min.	Typ.	
SC23-11EWA	HIGH EFFICIENCY RED (GaAsP/GaP)	WHITE DIFFUSED	4700	18000	Common Cathode.Rt. Hand Decimal

Electrical / Optical Characteristics at T_A=25°C

Symbol	Parameter	Device	Typ.	Max.	Units	Test Conditions
λ_{peak}	Peak Wavelength	High Efficiency Red	627		nm	I _F =20mA
λ_D	Dominant Wavelength	High Efficiency Red	625		nm	I _F =20mA
$\Delta\lambda_{1/2}$	Spectral Line Half-width	High Efficiency Red	45		nm	I _F =20mA
C	Capacitance	High Efficiency Red	15		pF	V _F =0V;f=1MHz
V _F	Forward Voltage Per Segment or (Dp)	High Efficiency Red	8.2 (4.0)	10 (5)	V	I _F =20mA
I _R	Reverse Current Per Segment or (Dp)	High Efficiency Red		10	uA	V _R = 20V (V _R = 10V)

Absolute Maximum Ratings at T_A=25°C

Parameter	High Efficiency Red	Units
Power dissipation Per Segment or (Dp)	300(150)	mW
DC Forward Current Per Segment or (Dp)	30	mA
Peak Forward Current [1] Per Segment or (Dp)	160	mA
Reverse Voltage Per Segment or (Dp)	20(10)	V
Operating/Storage Temperature	-40°C To +85°C	
Lead Solder Temperature [2]	260°C For 5 Seconds	

Notes:

- 1/10 Duty Cycle, 0.1ms Pulse Width.
- 2mm below package base.

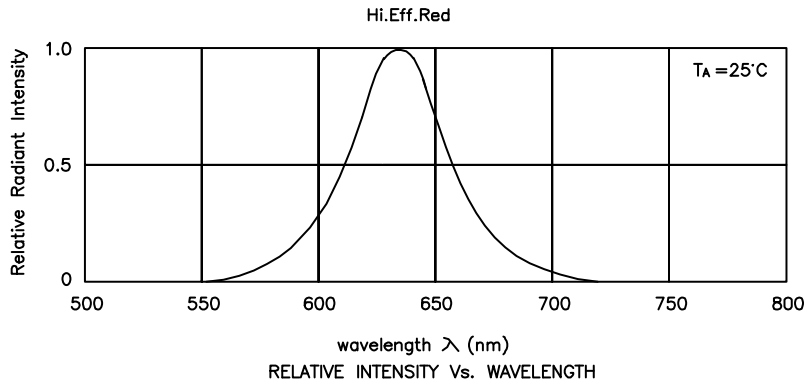

High Efficiency Red

SC23-11EWA

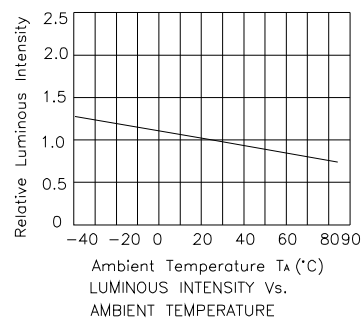
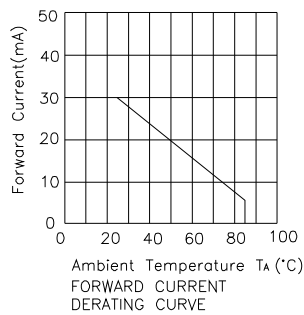
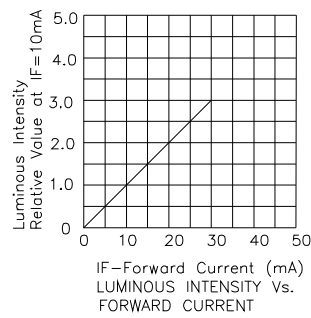
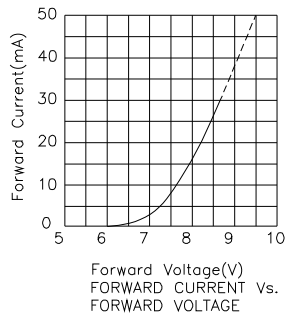

PACKING & LABEL SPECIFICATIONS

SC23-11EWA

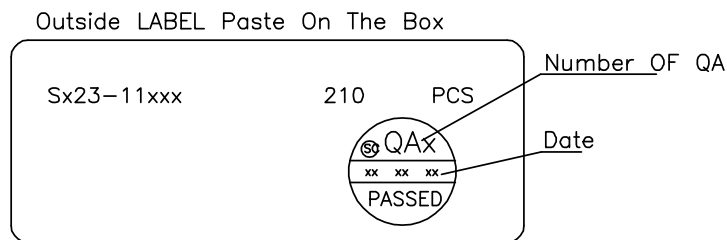
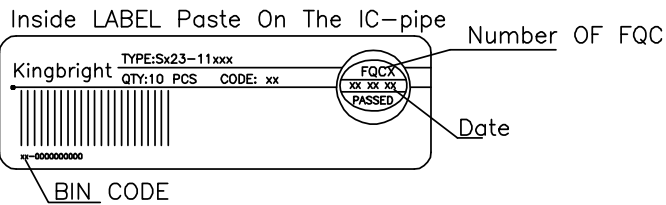
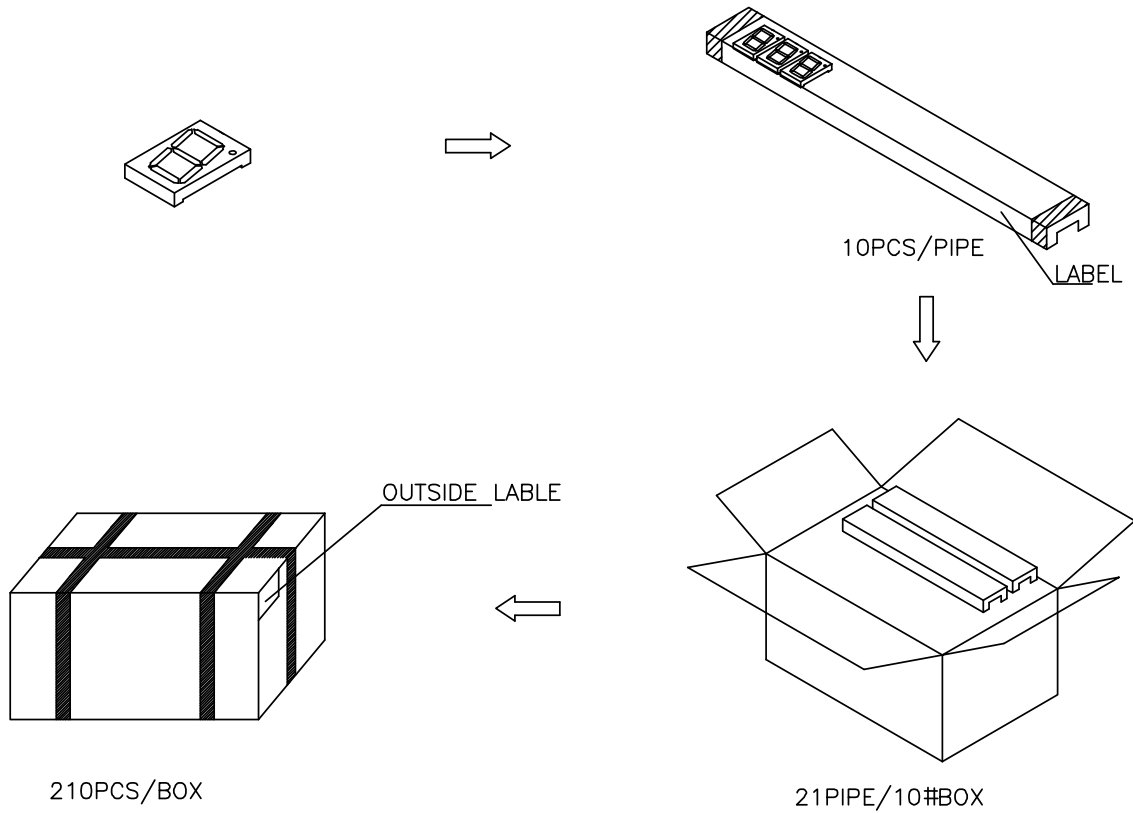

Remarks:

If special sorting is required (e.g. binning based on forward voltage, Luminous intensity/ luminous flux, or wavelength), the typical accuracy of the sorting process is as follows:

1. Wavelength: +/-1nm
2. Luminous intensity/ luminous flux: +/-15%
3. Forward Voltage: +/-0.1V

Note: Accuracy may depend on the sorting parameters.