

THIRD ANGLE
PROJECTION

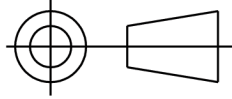

REMOVE ALL BURRS
& SHARP EDGES

REVISIONS	DATE
	2002/06/19

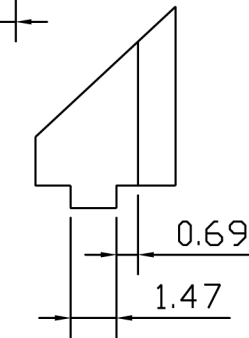
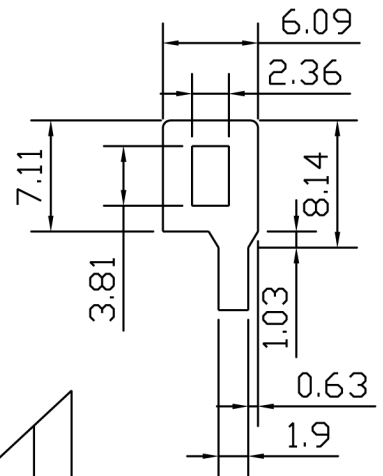
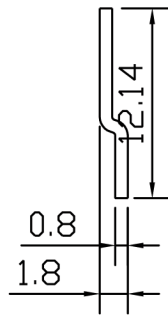
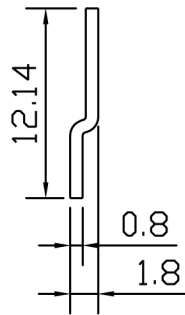
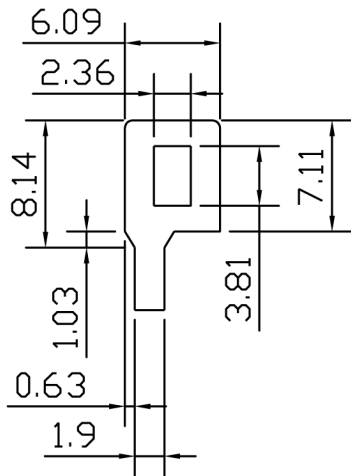
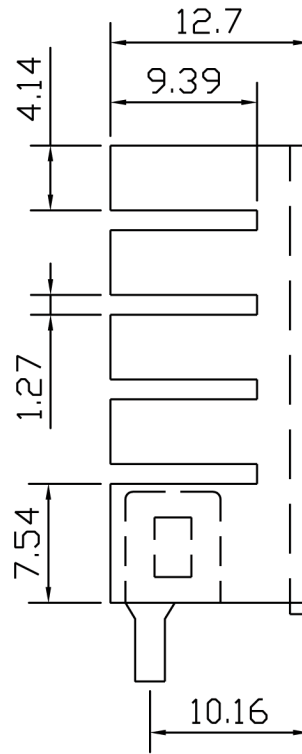
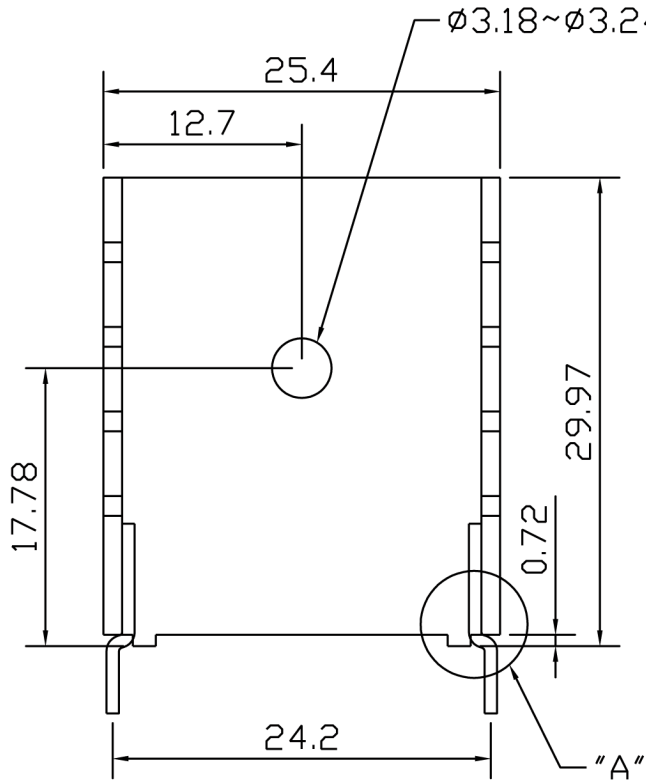

"A" 2:1

TOLERANCE UNIT ± 0.2	MATERIAL: AL 1100 T=1.2MM	TITLE: HEAT SINK
	FINISHED: BLACK ANODIZED PIN:C.R.S. TIN PLATED	PART NO : BK-T220-0042-002
	SCALE :	DRAWING NO :
	DIMENSIONS IN M/M	