

Data sheet | Item number: 2202-2701

Double-deck terminal block; with push-button; Through/through terminal block; L/L; without marker carrier; suitable for Ex e II applications; for DIN-rail 35 x 15 and 35 x 7.5; 2.5 mm²; Push-in CAGE CLAMP®; 2,50 mm²; gray

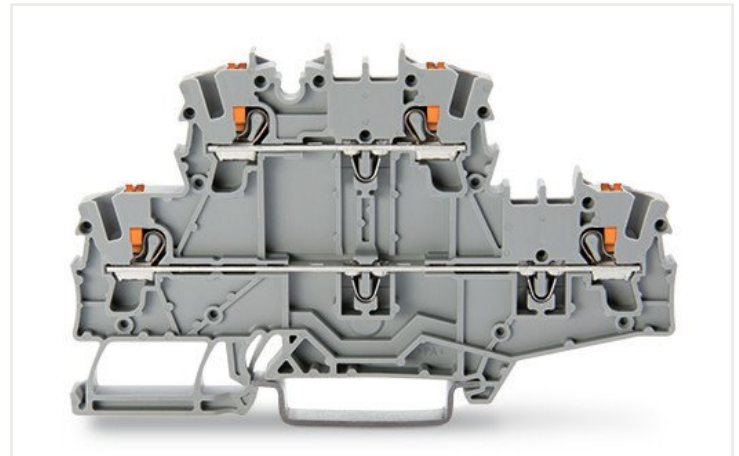

<https://www.wago.com/2202-2701>

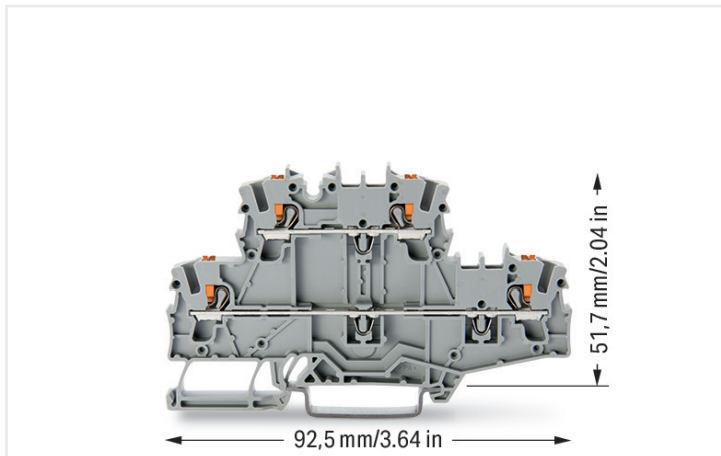

Electrical data

Ratings per IEC/EN

Ratings per	IEC/EN 60947-7-1
Nominal voltage (III/3)	800 V
Rated impulse voltage (III/3)	8 kV
Rated current	24 A
Legend (ratings)	(III / 3) \triangleq Overvoltage category III / Pollution degree 3

Ratings per UL

Approvals per	UL 1059
Rated voltage UL (Use Group B)	600 V
Rated current UL (Use Group B)	20 A
Rated voltage UL (Use Group C)	600 V
Rated current UL (Use Group C)	20 A

Ratings per CSA

Approvals per	CSA 22.2 No 158
Rated voltage CSA (Use Group B)	600 V
Rated current CSA (Use Group B)	24 A
Rated voltage CSA (Use Group C)	600 V
Rated current CSA (Use Group C)	24 A

Ex information

Reference hazardous areas	See Downloads – Documentation – Additional Information: Technical Section; Technical explanations
Ratings per	ATEX: PTB 18 ATEX 1005 U / IECEx: PTB 18.0012U (Ex eb IIC Gb)
Rated voltage EN (Ex e II)	550 V
Rated current (Ex e II)	17.5 A
Rated current (Ex e II) with jumper	17 A

Power loss

Power loss, per pole (potential)	0.7661 W
Rated current I_N for specified power loss	24 A
Resistance value for specified, current-dependent power loss	0.00133 Ω

Connection data

Total number of connection points	4
Total number of potentials	2
Number of levels	2
Number of jumper slots	4

Connection 1

Connection technology	Push-in CAGE CLAMP®
Number of connection points	2
Actuation type	Push-button
Connectable conductor materials	Copper
Nominal cross-section	2.5 mm ²
Solid conductor	0.25 ... 4 mm ² / 22 ... 12 AWG
Solid conductor; push-in termination	0.75 ... 4 mm ² / 18 ... 12 AWG
Fine-stranded conductor	0.25 ... 4 mm ² / 22 ... 12 AWG
Fine-stranded conductor; with insulated ferrule	0.25 ... 2.5 mm ² / 22 ... 14 AWG
Fine-stranded conductor; with ferrule; push-in termination	1 ... 2.5 mm ² / 18 ... 14 AWG
Note (conductor cross-section)	Depending on the conductor characteristic, a conductor with a smaller cross-section can also be inserted via push-in termination.
Strip length	10 ... 12 mm / 0.39 ... 0.47 inches
Wiring direction	Front-entry wiring

Connection 2

Number of connection points 2	2
-------------------------------	---

Physical data

Width	5.2 mm / 0.205 inches
Height	92.5 mm / 3.642 inches
Depth from upper-edge of DIN-rail	51.7 mm / 2.035 inches

Mechanical data

Potential marking	L/L
Mounting type	DIN-35 rail
Marking level	Center/side marking

Material data

Note (material data)	Information on material data can be found here
Color	gray
Material group	I
Insulation material	Polyamide (PA66)
Flammability class per UL94	V0
Fire load	0 MJ
Weight	12.5 g

Environmental requirements

Processing temperature	-35 ... +85 °C
Continuous operating temperature	-60 ... +105 °C

Commercial data

ETIM 8.0	EC000897
ETIM 7.0	EC000897
PU (SPU)	50 Stück
Packaging type	Box
Country of origin VKOrg Germany	DE
GTIN	4055143844598
Customs tariff number VKOrg Germany	85369010000

Approvals and certificates

Ex-Approvals



Approval	Standard	Certificate name
AEx Underwriters Laboratories Inc.	UL 60079	E185892 (AEx eb IIC resp. Ex eb IIC)
ATEX Physikalisch Technische Bundesanstalt	EN IEC 60079-0	PTB 18 ATEX 1005 U (II 2 G Ex eb IIC Gb bzw. I M 2 Ex eb I Mb)
IECEX Physikalisch Technische Bundesanstalt	IEC 60079	IECEX PTB 18.0012U (Ex eb IIC Gb and Ex eb I Mb)

Country specific Approvals



Approval	Standard	Certificate name
CCA DEKRA Certification B.V.	EN 60947	NTR NL-7901
CSA DEKRA Certification B.V.	C22.2	70173745
KEMA/KEUR DEKRA Certification B.V.	EN 60947	71-121544

UL-Approvals



Approval	Standard	Certificate name
UL Underwriters Laboratories Inc.	UL 1059	E45172

Downloads

Environmental Product Compliance

Compliance Search

Environmental Product
Compliance 2202-2701



Documentation

Additional Information

Technical Section	pdf 2142.18 KB	↓
-------------------	-------------------	-------------------

Bid Text

2202-2701	20.05.2019	xml 4.17 KB	↓
2202-2701	20.05.2019	docx 14.95 KB	↓

CAD/CAE-Data

CAD data

2D/3D Models 2202-2701	↓
---------------------------	-------------------

CAE data

EPLAN Data Portal 2202-2701	↓
ZUKEN Portal 2202-2701	↓

1 Compatible products

1.1 Required accessories

1.1.1 End plate

1.1.1.1 End plate



Item no.: 2002-2791

End plate; 0.8 mm thick; gray

Item no.: 2002-2792

End plate; 0.8 mm thick; orange

1.2 Optional accessories

1.2.1 DIN-rail

1.2.1.1 Mounting accessories



Item no.: 210-196

Aluminum carrier rail; 35 x 8.2 mm; 1.6 mm thick; 2 m long; unslotted; similar to EN 60715; silver-colored



Item no.: 210-198

Copper carrier rail; 35 x 15 mm; 2.3 mm thick; 2 m long; unslotted; according to EN 60715; copper-colored



Item no.: 210-508

Steel carrier rail; 35 x 15 mm; 1.5 mm thick; 2 m long; slotted; galvanized; similar to EN 60715; silver-colored



Item no.: 210-197

Steel carrier rail; 35 x 15 mm; 1.5 mm thick; 2 m long; slotted; similar to EN 60715; silver-colored



Item no.: 210-506

Steel carrier rail; 35 x 15 mm; 1.5 mm thick; 2 m long; unslotted; galvanized; similar to EN 60715; silver-colored



Item no.: 210-114

Steel carrier rail; 35 x 15 mm; 1.5 mm thick; 2 m long; unslotted; similar to EN 60715; silver-colored



Item no.: 210-118

Steel carrier rail; 35 x 15 mm; 2.3 mm thick; 2 m long; unslotted; according to EN 60715; silver-colored



Item no.: 210-115

Steel carrier rail; 35 x 7.5 mm; 1 mm thick; 2 m long; slotted; according to EN 60715; "Hole width 18 mm; silver-colored



Item no.: 210-112

Steel carrier rail; 35 x 7.5 mm; 1 mm thick; 2 m long; slotted; according to EN 60715; "Hole width 25 mm; silver-colored



Item no.: 210-504

Steel carrier rail; 35 x 7.5 mm; 1 mm thick; 2 m long; slotted; galvanized; according to EN 60715; silver-colored



Item no.: 210-113

Steel carrier rail; 35 x 7.5 mm; 1 mm thick; 2 m long; unslotted; according to EN 60715; silver-colored



Item no.: 210-505

Steel carrier rail; 35 x 7.5 mm; 1 mm thick; 2 m long; unslotted; galvanized; according to EN 60715; silver-colored

1.2.2 Ferrule

1.2.2.1 Ferrule



Item no.: 216-241

Ferrule; Sleeve for 0.5 mm² / 20 AWG; insulated; electro-tin plated; electrolytic copper; gastight crimped; acc. to DIN 46228, Part 4/09.90; white



Item no.: 216-263

Ferrule; Sleeve for 1 mm² / AWG 18; insulated; electro-tin plated; electrolytic copper; gastight crimped; acc. to DIN 46228, Part 4/09.90; red



Item no.: 216-266

Ferrule; Sleeve for 2.5 mm² / AWG 14; insulated; electro-tin plated; electrolytic copper; gastight crimped; acc. to DIN 46228, Part 4/09.90; blue



Item no.: 216-242

Ferrule; Sleeve for 0.75 mm² / 18 AWG; insulated; electro-tin plated; electrolytic copper; gastight crimped; acc. to DIN 46228, Part 4/09.90; gray



Item no.: 216-244

Ferrule; Sleeve for 1.5 mm² / AWG 16; insulated; electro-tin plated; electrolytic copper; gastight crimped; acc. to DIN 46228, Part 4/09.90; black



Item no.: 216-262

Ferrule; Sleeve for 0.75 mm² / 18 AWG; insulated; electro-tin plated; electrolytic copper; gastight crimped; acc. to DIN 46228, Part 4/09.90; gray



Item no.: 216-264

Ferrule; Sleeve for 1.5 mm² / AWG 16; insulated; electro-tin plated; electrolytic copper; gastight crimped; acc. to DIN 46228, Part 4/09.90; black



Item no.: 216-243

Ferrule; Sleeve for 1 mm² / AWG 18; insulated; electro-tin plated; electrolytic copper; gastight crimped; acc. to DIN 46228, Part 4/09.90; red



Item no.: 216-246

Ferrule; Sleeve for 2.5 mm² / AWG 14; insulated; electro-tin plated; electrolytic copper; gastight crimped; acc. to DIN 46228, Part 4/09.90; blue

1.2.3 Installation

1.2.3.1 Mounting accessories



Item no.: 709-169

Cover carrier; Type 3; gray



Item no.: 709-156

Cover; Type 3; suitable for cover carrier, type 3; 1 m long; transparent

1.2.4 Insulation stop

1.2.4.1 Insulation stop



Item no.: 2002-171

Insulation stop; 0.25 - 0.5 mm²; 5 pieces/strip; light gray



Item no.: 2002-172

Insulation stop; 0.75 - 1 mm²; 5 pieces/strip; dark gray

1.2.5 Jumper

1.2.5.1 Jumper



Item no.: 2002-400

Continuous jumper; 2-way; insulated; light gray



Item no.: 2002-423/000-006

Continuous jumper; from 1 to 3; insulated; blue



Item no.: 2002-423

Continuous jumper; from 1 to 3; insulated; light gray



Item no.: 2002-423/000-005

Continuous jumper; from 1 to 3; insulated; red



Item no.: 2002-406/020-000

Delta jumper; insulated; light gray



Item no.: 2002-410/000-006

Jumper; 10-way; insulated; blue



Item no.: 2002-410

Jumper; 10-way; insulated; light gray



Item no.: 2002-410/000-005

Jumper; 10-way; insulated; red



Item no.: 2002-402/000-006

Jumper; 2-way; insulated; blue



Item no.: 2002-402

Jumper; 2-way; insulated; light gray



Item no.: 2002-402/000-005

Jumper; 2-way; insulated; red



Item no.: 2002-403/000-006

Jumper; 3-way; insulated; blue



Item no.: 2002-403

Jumper; 3-way; insulated; light gray



Item no.: 2002-403/000-005

Jumper; 3-way; insulated; red



Item no.: 2002-404/000-006











Jumper; 4-way; insulated; blue



Item no.: 2002-404

Jumper; 4-way; insulated; light gray

1.2.5.1 Jumper

 Item no.: 2002-404/000-005 Jumper; 4-way; insulated; red	 Item no.: 2002-405/000-006 Jumper; 5-way; insulated; blue	 Item no.: 2002-405 Jumper; 5-way; insulated; light gray	 Item no.: 2002-405/000-005 Jumper; 5-way; insulated; red
 Item no.: 2002-406/000-006 Jumper; 6-way; insulated; blue	 Item no.: 2002-406 Jumper; 6-way; insulated; light gray	 Item no.: 2002-406/000-005 Jumper; 6-way; insulated; red	 Item no.: 2002-407/000-006 Jumper; 7-way; insulated; blue
 Item no.: 2002-407 Jumper; 7-way; insulated; light gray	 Item no.: 2002-407/000-005 Jumper; 7-way; insulated; red	 Item no.: 2002-408/000-006 Jumper; 8-way; insulated; blue	 Item no.: 2002-408 Jumper; 8-way; insulated; light gray
 Item no.: 2002-408/000-005 Jumper; 8-way; insulated; red	 Item no.: 2002-409/000-006 Jumper; 9-way; insulated; blue	 Item no.: 2002-409 Jumper; 9-way; insulated; light gray	 Item no.: 2002-409/000-005 Jumper; 9-way; insulated; red
 Item no.: 2002-440 Jumper; from 1 to 10; insulated; light gray	 Item no.: 2002-433 Jumper; from 1 to 3; insulated; light gray	 Item no.: 2002-434 Jumper; from 1 to 4; insulated; light gray	 Item no.: 2002-435 Jumper; from 1 to 5; insulated; light gray
 Item no.: 2002-436 Jumper; from 1 to 6; insulated; light gray	 Item no.: 2002-437 Jumper; from 1 to 7; insulated; light gray	 Item no.: 2002-438 Jumper; from 1 to 8; insulated; light gray	 Item no.: 2002-439 Jumper; from 1 to 9; insulated; light gray
 Item no.: 2002-480 Staggered jumper; 10-way; insulated; light gray	 Item no.: 2002-481 Staggered jumper; 11-way; insulated; light gray	 Item no.: 2002-482 Staggered jumper; 12-way; insulated; light gray	 Item no.: 2002-473/011-000 Staggered jumper; 2-way; from 1 to 3; insulated; light gray
 Item no.: 2002-472 Staggered jumper; 2-way; insulated; light gray	 Item no.: 2002-473 Staggered jumper; 3-way; insulated; light gray	 Item no.: 2002-475/011-000 Staggered jumper; 3-way; insulated; light gray	 Item no.: 2002-474 Staggered jumper; 4-way; insulated; light gray
 Item no.: 2002-475 Staggered jumper; 5-way; insulated; light gray	 Item no.: 2002-476 Staggered jumper; 6-way; insulated; light gray	 Item no.: 2002-477 Staggered jumper; 7-way; insulated; light gray	 Item no.: 2002-478 Staggered jumper; 8-way; insulated; light gray
 Item no.: 2002-479 Staggered jumper; 9-way; insulated; light gray	 Item no.: 2002-477/011-000 Staggered jumper; insulated; light gray	 Item no.: 2002-479/011-000 Staggered jumper; insulated; light gray	 Item no.: 2002-481/011-000 Staggered jumper; insulated; light gray
 Item no.: 2002-405/011-000 Star point jumper; 3-way; insulated; light gray	 Item no.: 2002-492 Vertical jumper; insulated; light gray	 Item no.: 2002-492/000-012 Vertical jumper; insulated; orange	 Item no.: 210-103 Wire commoning chain; insulated; black
 Item no.: 210-123 Wire commoning chain; insulated; blue			

1.2.6 Marking

1.2.6.1 Group marker carrier



Item no.: 2009-191
Group marker carrier; gray

Item no.: 2009-192
Group marker carrier; gray

Item no.: 2009-193
Group marker carrier; gray

1.2.6.2 Marker

Item no.: 2009-145/000-006
Mini-WSB Inline; for Smart Printer; 1700 pieces on roll; stretchable 5 - 5.2 mm; plain; snap-on type; blue

Item no.: 2009-145/000-007
Mini-WSB Inline; for Smart Printer; 1700 pieces on roll; stretchable 5 - 5.2 mm; plain; snap-on type; gray

Item no.: 2009-145/000-023
Mini-WSB Inline; for Smart Printer; 1700 pieces on roll; stretchable 5 - 5.2 mm; plain; snap-on type; green

Item no.: 2009-145/000-012
Mini-WSB Inline; for Smart Printer; 1700 pieces on roll; stretchable 5 - 5.2 mm; plain; snap-on type; orange

Item no.: 2009-145/000-005
Mini-WSB Inline; for Smart Printer; 1700 pieces on roll; stretchable 5 - 5.2 mm; plain; snap-on type; red

Item no.: 2009-145/000-024
Mini-WSB Inline; for Smart Printer; 1700 pieces on roll; stretchable 5 - 5.2 mm; plain; snap-on type; violet

Item no.: 2009-145
Mini-WSB Inline; for Smart Printer; 1700 pieces on roll; stretchable 5 - 5.2 mm; plain; snap-on type; white

Item no.: 2009-145/000-002
Mini-WSB Inline; for Smart Printer; 1700 pieces on roll; stretchable 5 - 5.2 mm; plain; snap-on type; yellow



Item no.: 248-501/000-006
Mini-WSB marking card; as card; not stretchable; plain; snap-on type; blue

Item no.: 248-501/000-007
Mini-WSB marking card; as card; not stretchable; plain; snap-on type; gray

Item no.: 248-501/000-023
Mini-WSB marking card; as card; not stretchable; plain; snap-on type; green

Item no.: 248-501/000-017
Mini-WSB marking card; as card; not stretchable; plain; snap-on type; light green



Item no.: 248-501/000-012
Mini-WSB marking card; as card; not stretchable; plain; snap-on type; orange

Item no.: 248-501/000-005
Mini-WSB marking card; as card; not stretchable; plain; snap-on type; red

Item no.: 248-501/000-024
Mini-WSB marking card; as card; not stretchable; plain; snap-on type; violet

Item no.: 248-501
Mini-WSB marking card; as card; not stretchable; plain; snap-on type; white



Item no.: 248-501/000-002
Mini-WSB marking card; as card; not stretchable; plain; snap-on type; yellow

Item no.: 793-5501/000-006
WMB marking card; as card; for terminal block width 5 - 17.5 mm; stretchable 5 - 5.2 mm; plain; snap-on type; blue

Item no.: 793-5501/000-014
WMB marking card; as card; for terminal block width 5 - 17.5 mm; stretchable 5 - 5.2 mm; plain; snap-on type; brown

Item no.: 793-5501/000-007
WMB marking card; as card; for terminal block width 5 - 17.5 mm; stretchable 5 - 5.2 mm; plain; snap-on type; gray



Item no.: 793-5501/000-023
WMB marking card; as card; for terminal block width 5 - 17.5 mm; stretchable 5 - 5.2 mm; plain; snap-on type; green

Item no.: 793-5501/000-017
WMB marking card; as card; for terminal block width 5 - 17.5 mm; stretchable 5 - 5.2 mm; plain; snap-on type; light green

Item no.: 793-5501/000-012
WMB marking card; as card; for terminal block width 5 - 17.5 mm; stretchable 5 - 5.2 mm; plain; snap-on type; orange

Item no.: 793-5501/000-005
WMB marking card; as card; for terminal block width 5 - 17.5 mm; stretchable 5 - 5.2 mm; plain; snap-on type; red



Item no.: 793-5501/000-024
WMB marking card; as card; for terminal block width 5 - 17.5 mm; stretchable 5 - 5.2 mm; plain; snap-on type; violet

Item no.: 793-5501
WMB marking card; as card; for terminal block width 5 - 17.5 mm; stretchable 5 - 5.2 mm; plain; snap-on type; white

Item no.: 793-5501/000-002
WMB marking card; as card; for terminal block width 5 - 17.5 mm; stretchable 5 - 5.2 mm; plain; snap-on type; yellow

Item no.: 793-501/000-006
WMB marking card; as card; not stretchable; plain; snap-on type; blue



Item no.: 793-501/000-007
WMB marking card; as card; not stretchable; plain; snap-on type; gray

Item no.: 793-501/000-023
WMB marking card; as card; not stretchable; plain; snap-on type; green

Item no.: 793-501/000-017
WMB marking card; as card; not stretchable; plain; snap-on type; light green

Item no.: 793-501/000-012
WMB marking card; as card; not stretchable; plain; snap-on type; orange



Item no.: 793-501/000-005
WMB marking card; as card; not stretchable; plain; snap-on type; red

Item no.: 793-501/000-024
WMB marking card; as card; not stretchable; plain; snap-on type; violet

Item no.: 793-501
WMB marking card; as card; not stretchable; plain; snap-on type; white

Item no.: 793-501/000-002
WMB marking card; as card; not stretchable; plain; snap-on type; yellow



Item no.: 2009-115/000-006
WMB-Inline; for Smart Printer; 1500 pieces on roll; stretchable 5 - 5.2 mm; plain; snap-on type; blue

Item no.: 2009-115/000-007
WMB-Inline; for Smart Printer; 1500 pieces on roll; stretchable 5 - 5.2 mm; plain; snap-on type; gray

Item no.: 2009-115/000-023
WMB-Inline; for Smart Printer; 1500 pieces on roll; stretchable 5 - 5.2 mm; plain; snap-on type; green

Item no.: 2009-115/000-017
WMB-Inline; for Smart Printer; 1500 pieces on roll; stretchable 5 - 5.2 mm; plain; snap-on type; light green

1.2.6.2 Marker



Item no.: 2009-115/000-012

WMB-Inline; for Smart Printer; 1500 pieces on roll; stretchable 5 - 5.2 mm; plain; snap-on type; orange



Item no.: 2009-115/000-005

WMB-Inline; for Smart Printer; 1500 pieces on roll; stretchable 5 - 5.2 mm; plain; snap-on type; red



Item no.: 2009-115/000-024

WMB-Inline; for Smart Printer; 1500 pieces on roll; stretchable 5 - 5.2 mm; plain; snap-on type; violet



Item no.: 2009-115

WMB-Inline; for Smart Printer; 1500 pieces on roll; stretchable 5 - 5.2 mm; plain; snap-on type; white



Item no.: 2009-115/000-002

WMB-Inline; for Smart Printer; 1500 pieces on roll; stretchable 5 - 5.2 mm; plain; snap-on type; yellow

1.2.6.3 Marker carrier



Item no.: 2002-121

Adaptor; gray



Item no.: 2002-161

Adaptor; gray



Item no.: 2009-198

Adaptor; gray

1.2.6.4 Marking strip



Item no.: 2009-110

Marking strips; for Smart Printer; on reel; not stretchable; plain; snap-on type; white

1.2.7 Push-in type wire jumper

1.2.7.1 Jumper



Item no.: 2009-414

Push-in type wire jumper; 1.5 mm²; insulated; 110 mm long; black



Item no.: 2009-414/000-005

Push-in type wire jumper; 1.5 mm²; insulated; 110 mm long; black



Item no.: 2009-416

Push-in type wire jumper; 1.5 mm²; insulated; 250 mm long; black



Item no.: 2009-414/000-006

Push-in type wire jumper; insulated; 110 mm long; black



Item no.: 2009-412

Push-in type wire jumper; insulated; 60 mm long; black

1.2.8 Test and measurement

1.2.8.1 Testing accessories



Item no.: 2009-174

Test plug adapter; for 4 mm Ø test plugs; for testing TOPJOB®S rail-mounted terminal blocks; gray



Item no.: 2009-182

Testing tap; for max. 2.5 mm²; tool-free connection for individual test wires 0.08 - 2.5 mm; gray

1.2.9 Tool

1.2.9.1 Operating tool



Item no.: 210-658

Operating tool; Blade: 3.5 x 0.5 mm; with a partially insulated shaft; angled; short; multicoloured



Item no.: 210-720

Operating tool; Blade: 3.5 x 0.5 mm; with a partially insulated shaft; multicoloured

Installation notes

Conductor termination



All conductor types at a glance



Push-in termination of solid and ferruled conductors



Push-in termination of solid and ferruled conductors

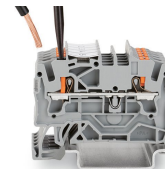

Insert fine-stranded conductors via operating tool.



Removing all conductors via operating tool.

Commoning

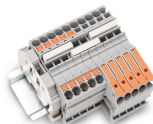

Insert a push-in type jumper bar and push down until it hits the backstop.

Testing



Testing with a 2 mm Ø test plug (max. 42 V).

Marking

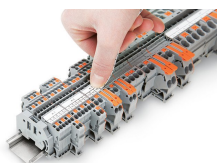

Snapping a marking strip into a marker slot.

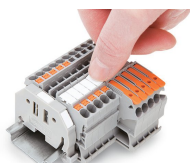

Snapping a marking strip into the marker slot.

Subject to changes. Please also observe the further product documentation!

Current addresses can be found at: www.wago.com